

# Flotronics

## AUTOMATION

STRUCTURES



CONTROLS



MOTION



SENSORS



SAFETY



OFFERING COMPLETE **AUTOMATION SOLUTIONS**

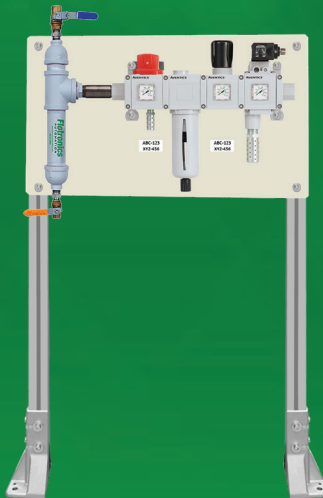
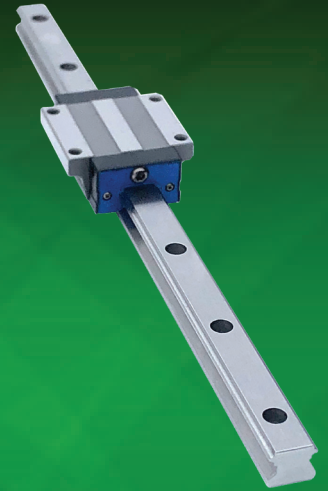
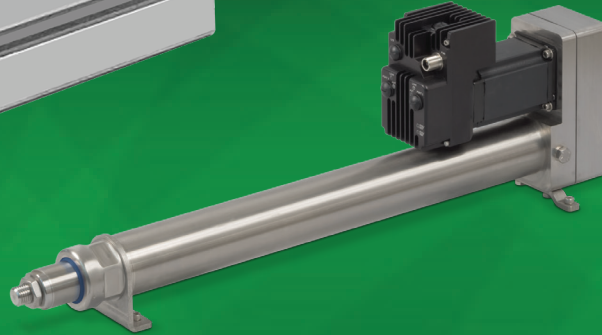
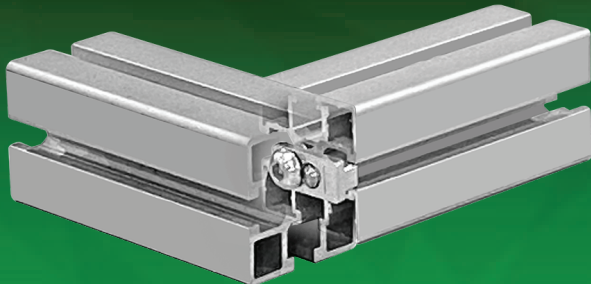
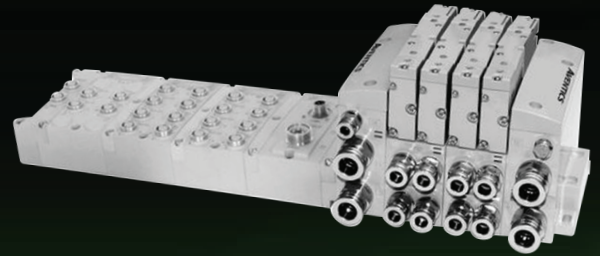

### More Than Just Automation Products!

Consultation from Automation Specialist

- Pneumatic Products/Controls
- Actuators/Mechanical Systems
- Safety Products

Design and Build

- Pneumatic Panels/Pneumatic Circuits
- Aluminum Framing Systems
- Product Integration

Technical Resources

- Training/Education
- Support/Troubleshooting
- Product Literature & Support Tools

### Flotronics Companies

THE **PneumaticStore**  
.COM

**The #1 Pneumatic  
Supply Store**

**Flotronics' Online Store**

- Log in for Discounted Price
- Check Stock
- Check Order History
- Generate Quotes
- Knowledge Center
- Catalogs
- Get Solid Models & Tech Drawings

**MODULAR  
SOLUTIONS**

**Structural Aluminum**

- Extruded Aluminum Profile System Manufacturer
- Custom Engineered Solutions
- Fast, Easy & Lightweight Structural System
- CNC Services
- Curved Aluminum

*flo* **FLEX**  
SYSTEMS

**Pneumatic Panel & Build**

- FRL Panels
- Air Logic
- Valve Boards
- Pneumatic Control Enclosures

### Pneumatic Valves & Fieldbus

- Aventics
- Numatics
- Rexroth Pneumatics
- Asco
- Aladco
- Woodward (H. R. Textron)
- Domin
- Assured Automation
- Enfield Technologies

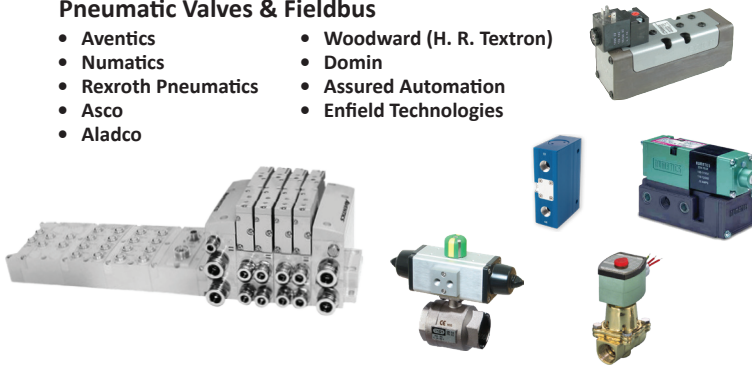

### Fittings, Flow Controls, Tubing, & Accessories

- Aventics
- Asco/Numatics
- Rexroth Pneumatics
- FloFlex Inc
- Aignep
- Pisco
- AirTAC
- Twintec
- Coilhose



### Pneumatic & Electric Actuators

- Aventics
- Numatics
- Tolomatic
- Rollon
- Nexen
- AirTAC
- IAI - Intelligent Actuator
- Rexroth Pneumatics
- Thomson Industries
- Oriental Motor
- BTM

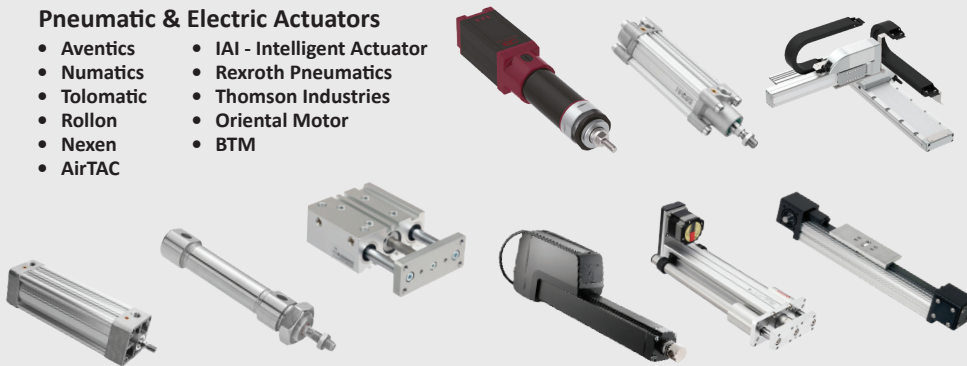

### Vision

- SensoPart



### Air Preparation & Pneumatic Sensors

- Aventics
- AirTAC
- CoilHose
- Airtrol
- Asco Numatics
- Rexroth Pneumatics
- Autonics
- Arrow Pneumatics

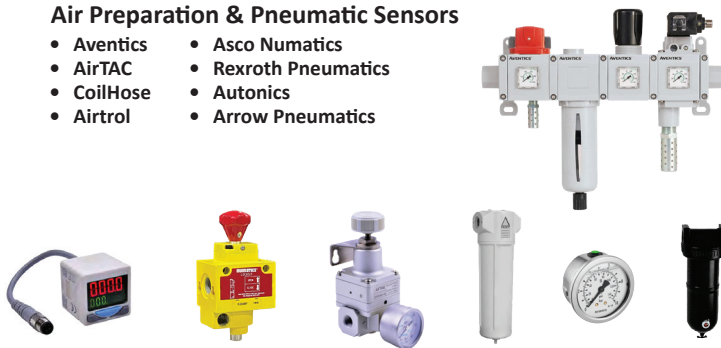

### Design & Build Services

- Pneumatic Panels
- Pneumatic Circuits
- Aluminum Framing Systems
- Product Integration

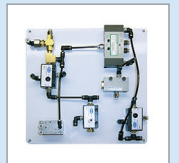
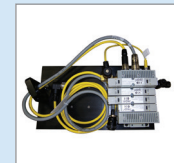
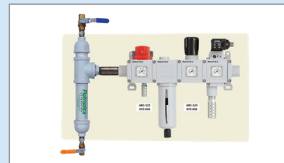
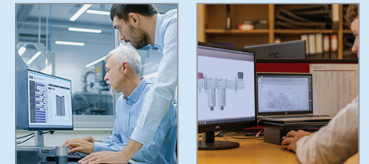

### Connectivity

- Mencom
- Canfield
- Remke
- Aventics
- ELCO
- HTM
- Numatics
- Rexroth Pneumatics
- Ilme



### Vacuum & End of Arm Tooling

- Schmalz
- Aventics
- Numatics
- Pisco
- VMECA
- Rexroth Pneumatics
- Flo-Flex Systems (Custom EOA Control & Filtration Systems/Enclosures)



# 3 WAYS TO ORDER



(248) 625-8890



sales@flotronicsautomation.com



www.thepneumaticstore.com

## Sensors & Sensor Controls

- Aventics
- Numatics
- Autonics
- HTM
- ELCO
- ReeR
- Canfield
- Rexroth Pneumatics
- Fargo Controls
- SensoPart



## Safety Components & Electrical Controls

- ReeR
- HTM
- Autonics
- Recora
- Aventics
- Numatics
- Rexroth Pneumatics
- Panasonic



## Motors, Drives, Gear Boxes, Clutches, Brakes, & Encoders

- Tolomatic
- Nexen
- Cone Drive
- Thomson Industries
- Oriental Motor
- Autonics



## Bearings, Rails, Shafting, Ball, & Lead Screws

- Thomson Industries
- AirTAC
- Rollon/Timken
- Nexen



## Structural Aluminum, & Guarding

- Natural & Black Profile
- Machine Guarding
- Stairs & Mezzanines
- Profile Accessories
- Curved Aluminum
- Doors
- Posts
- Shelves

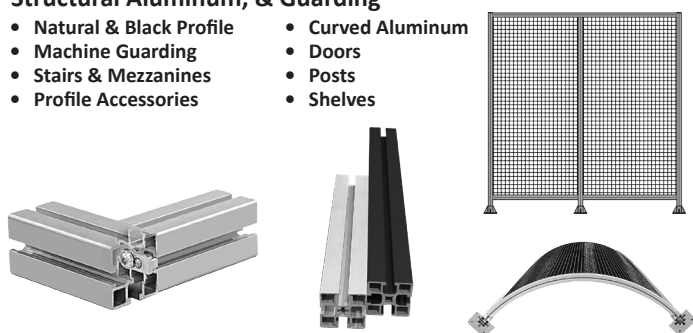

## Conveyors & Shuttles

- Available Types:
- Gravity & Ball Transfer
  - Heavy Duty & Chip
  - Belt & Timing Belt
  - Chain



## Enclosures For:

- Robotics
- Testing
- Light
- Equipment
- Noise Protection
- Welding & Laser Marking
- Temperature
- Custom Applications

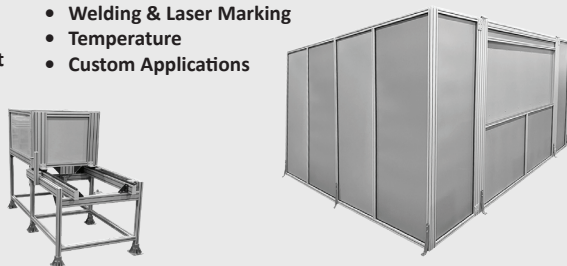

## Tables, Workbenches, Frames, & Displays

- Flow Racks
- Fixtures
- Test Stands
- Tables
- Workstations
- Trade Show Displays & Stands
- Custom Display Cases, Frames & Demo Stands



# AVENTICS™

Pneumatic Valves, Actuators, Rodless Cylinders, Vacuum, Proportional, Fittings, Tubing, FRLs, Flow Controls, & Accessories

# IAI

Quality and Innovation

Electric Actuators, Cartesian Gantries, Drives, & Motors

# MODULAR SOLUTIONS

Structural Aluminum Systems, Guarding, Enclosures, Stairs & Mezzanines, Lean Tube Products, & Conveyors

# REER

Light Curtains, Controllers, Interfaces, Sensors, Measurement Light Curtains, & Safety Devices

# THOMSON

Linear Motion. Optimized.™

Shafting, Profile Bearings/Guides, Ball Bushing Bearings, Electric Actuators, & Lead & Ball Screws

# Tolomatic

EXCELLENCE IN MOTION.®

Electric & Pneumatic Actuators, Electric Motors & Drives, & Power Transmission

# AIGNEP

Universal Thread Push-In Fittings, Fittings, Flow Controls, & Pneumatic Accessories



Miniature Air & Vacuum Switches, Regulators, & Precision Orifices



Pneumatic Pilot Operated Check Valves

# Airtac

Linear Bearing & Rail Systems, Air Preparation, & Pneumatic Actuators

# ANDERSON FITTINGS

Brass Pipe, Adapter, & Compression Fittings

# ASCO™

General Service Solenoid Valves, "2-way", & "3-way" valves,

# ASSURED AUTOMATION

Automated & Manual Ball Valves, Process Valves, & Flow Meters

# Autonics

Sensors, HMIs, Electric Controllers, Counters, Pilot Lights, & Selector Switches

# BTM COMPANY

Power Clamps & Grippers, Air/Oil Cylinders, Clinching Components, Presses, & Tools



Connectors, Cylinder Switches, Sensors, Timers, Drain Valves, & Custom Products



Quick Connect Couplers, Blow Guns, Coiled Hose, & Air Preparation Products

# Cone Drive

Gear Boxes, Gear Drives, Clutches, Harmonic Gears, & Slewing Solutions

# DOMIN

High Precision Servo Valves

# DORNER

Conveyors for Automation, Packaging, Food Processing, Assembly, & More

# ELCO INDUSTRIAL AUTOMATION

Cables/Connectors, Junctions Blocks, & Industrial Networking

# ENFIELD TECHNOLOGIES

Proportional Pneumatic Servo Valves & Positioning Systems

# FARGO CONTROLS, INC.

Proximity Sensors, Counters, Rate Meters, Timers, & Power Supplies

# FLOFLEX

Push-In & Brass Fittings, Tubing, Ball Valves, & Blow Guns

# flex SYSTEMS

FRL Panels, Air Logic, Valve Boards, Pneumatic Control & FRL Enclosures, Fitting, & Robotic Dressing Kits

# Flotronics AUTOMATION BRAND SOLUTIONS

Drip Legs, Pilot Operated Check Valves, & Sub-D Connectors

# FreelinWade

A COILHOSE COMPANY

Tubing, Coiled Tubing, Fittings, & Tube Accessories

# HTM SENSORS

Sensors, Cables/Connectors, & Light Curtains



Connector, Plugs, & Socket Connectors

# MEM-CO FITTINGS, INC.

Miniature Metal Barb & Custom Fittings



Cables/Connectors, Junctions Blocks, & Industrial Networking

# MODULAR GUARDING SOLUTIONS

Easy to Configure Guarding Sections, Free Solid Models, & Easy to Use Order Guides

# nexen. numatics Orientalmotor

Rod Locks, Brakes, Clutches, & Ring Drives

Pneumatic Valves, Actuators, Rodless Cylinders, Vacuum, Proportional, Fittings, Tubing, FRLs, Flow Controls, & Accessories

Electric Motors & Drives, Electric Actuators, & Cooling Fans

Push-In Fittings, Flow Controls, Valves, Accessories, & Vacuum Products



# REGORA LEADERS IN PRESENCE DETECTION

Safety & Presence Detection Mats, Bed & Chair Sensors, Car Wash Treadles, & Sensors

# REMKE

Cord Grips, Cables/Connectors, & Specialty Cables

# Rexroth Pneumatics

Pneumatic Actuators & Rodless Cylinders, Proportional Valves, Vacuum, FRLs, Flow Controls, Fittings, Tubing, & Accessories.

# ROLLON®

Telescoping Guides, Linear Rail, Electric Actuators, & Actuator System Lines

# SCHMALZ

Vacuum Cups, Pumps, Grippers, Lifters, & Clamps

# SENSOPART

Vision, Cameras, & Sensors

# TWINTeC Inc

Quick Connect Multi-Tube Connectors

# VMECA™

Vacuum Cups, Pumps, Grippers, & Lifters

# WOODWARD

(Formerly H. R. Textron)  
High Precision Servo Valves

# Flotronics AUTOMATION

Automation Solutions Since 1986

# Flotronics AUTOMATION

sales@flotronicsautomation.com

www.flotronicsautomation.com

4260 Giddings Rd. - Auburn Hills, MI 48326

Phone: 248-625-8890